

Pradel

MODE D'EMPLOI



SMART MIRROR
MIRALITE CONNECT V2
60 | 90 | 120

La couleur et l'aspect peuvent différer selon le produit, et les spécifications peuvent être modifiées sans préavis pour améliorer les performances.



MODE D'EMPLOI

SMART MIRROR
MIRALITE CONNECT V2
60 | 90 | 120

TABLE DES MATIÈRES

2	CONCERNANT CE MANUEL
3	PRÉCAUTIONS DE SÉCURITÉ
8	CHAMP D'APPLICATION
9	INSTALLATION
12	TÉLÉCOMMANDE BLUETOOTH
13	CONFIGURATION & ENREGISTREMENT
14	MANIPULATION
16	MANIPULATION D'AFFICHAGE
17	INFORMATION PRODUIT
18	INFORMATION GÉNÉRALE
19	DÉPANNAGE

About this manual

Please read the corresponding instructions of this manual prior to the first usage of the device, even if the usage of electronic devices is familiar to you. Notice especially the chapter SAFETY PRECAUTIONS. Please do keep this manual in a safe place for future references. When selling the device or giving it away, absolutely give these directions for use.

Copyright

The contents of this manual are subject to change without notice to improve quality.

© 2017 ad notam AG, all rights reserved.

Use or reproduction of this manual in parts or entirely without the authorization of ad notam is prohibited.



An administration fee may be charged if either

- an engineer is called out at your request and there is no defect in the product (i.e. where you have failed to read this user manual)
- you bring the unit to a repair centre and there is no defect in the product (i.e. where you have failed to read this user manual)

The amount of such administration charge will be advised to you before any work or home visit is carried out.

Symbols



WARNING

A serious or fatal injury may result if instructions are not followed.



CAUTION

Injury or damage to property may result if instructions are not followed.



NOTE

Instructions followed by this symbol must be followed.



Electricity and safety

1. Never remove the housing covers or modify the product in any way. This can cause an electric shock or burn you.
2. Do not overload wall outlets, extension cords or adaptors above their capacity, since this can result in fire or electric shock.
3. Immediately cut power, if you notice that your product emits smoke, smells burnt or emits unusual noises and ask your specialist dealer for advice.
4. Do not allow the product to come into direct contact with liquids. Liquid in the housing can cause a fire, electric shock or damage the device. Immediately cut the power, if an item or liquid gets into the housing.
5. Keep small items away from the product. These may fall into the housing and causing a fire, an electric shock or damage the device. DO not attempt to get into the housing or plugs with wires or the like.
6. Only qualified specialist staff may carry out service tasks. Service work is necessary, if the unit has been damaged, e.g. if the mains plug or mains cable have been damaged, if liquid or items are present inside the device, if it has been exposed to rain, if it does not work properly or if it has fallen down.
7. Never touch uninsulated parts of the plug, if the device is connected to the power supply!
8. The device may only be operated with the provided power pack. The rated voltage is 100 – 240V ~ 50Hz. Use only cables suitable for your local power supply. Install the mains cable in such a way that it does not obstruct anyone. Ensure furthermore that the cable is not clamped, in particular at the plug, at the female connectors and where it exits the device. Do not install the mains cable in the proximity of heating elements and never place heavy items on the cable. Do not modify or arbitrary repair the mains cable.
9. Do not use any power cords or adapters other than those provided with this product! Use of power cords or adapters other than those provided with this product may cause fire, electric shock or malfunction.
10. The device is rated to be connected to a mains with rating max. 16A. The electrical installation need to be protected with 30 mA.
11. Never cut or damage the power cord!
12. Please disconnect the device from the power supply in th following cases:
 - The device is out of use for a lengthy period.
 - The device malfunctions or displays other unusual features, necessitating maintenance work.
 - During a thunderstorm or lightning.
13. Do not use multiple products with a single power socket.

CAUTION

RISK OF ELECTRIC SHOCK – DO NOT OPEN

Caution: to reduce the risk of electric shock, do not remove cover (or back). There are no user serviceable parts inside. Refer all servicing to qualified personnel.

SAFETY PRECAUTIONS



Installation

1. Avoid direct sun exposure, direct proximity to heat sources, outdoor installation or storing in a car. The product is specifically designed for indoor use only. There is the danger of fire and of electric shocks and damage to the device, if it is operated outdoors.
2. Do not place candles, insect repellants or cigarettes on top of the product. Do not install the product near to heat sources.
3. Keep the plastic packaging out of reach of children, children may suffocate.
4. Keep out of reach of children. Failure to observe this precaution could result in injury.
5. Edible oil, such as soybean oil, can damage or deform the product. Do not install the product in a kitchen or near a kitchen counter.
6. Do not drop the product while moving.
7. Do not set down the product on it's front (glass side) or corners.
8. Set down the product gently.
9. Structural measures must be accomplished for an on-wall installation. We decline any liability for the screws and screw anchors used on site.
10. The product is engineered vertical use only. Verify walls verticality and items vertical and horizontal alignment to prevent serious injuries and product damage.
11. Do not install the product alone on yourself. Two persons are required to perform a safe installation.
12. The corners and edges of the glass are very delicate. Take care that they do not hit the wall, ceiling or floor in any way to avoid damages and split-offs.
13. The surface of the glass is very sensitive. Do not use a cutter or knife to remove the protective foil in order to avoid scratches and other damages.
14. The product is delivered with a protective film covering the glass in order to avoid scratches and damages. Only remove the protective film once the product is installed and hanging safely on the wall.
15. Installing the product in an unusual place (a place exposed to a lot of fine dust, chemical substances, extreme temperatures or a significant presence of moisture, or a place where the product will operate continuously for an extended period of time) may seriously affect its performance and lifetime.
16. Parts of this product are made out of glass. Handle with care to avoid injury or damage. Always wear safety shoes and gloves when handling the products or its packaging.
17. There are numerous types of wall and structures, that's why we can not provide the fittings, screws and anchors for your wall. First determine the type of wall to which you want to attach the product in order to buy the appropriate fittings, screws and anchors.
18. Mounting this product requires structural measures and special skills. Refer exclusively to qualified personnel. Electrical connections must be performed by qualified professionals respecting national regulations and standards.

19. For installations in wet-rooms, such as bathrooms, specific installation guidelines apply. These regulations differ by region. Please contact a specialist for this. Therefore electrical installations are to be performed by a skilled technician, while observing the regulations of the standard DIN VDE 0100 T.701.

20. This product includes heavy, bulky and delicate items. To prevent damages to your product or injury to yourself or to others, prepare the installation environment properly. Clean the handling and installation environments properly before installation. Before installation cushion the floor properly using soft anti slip mats near the handling areas. Lay the items gently on these cushioned anti slip surfaces when needed.



Operation

1. There is a high voltage inside the product. Never disassemble, repair or modify the product yourself.
2. Before moving the product, disconnect the power cable.
3. If the product is dropped or the outer case is damaged, disconnect the power cord. Then contact the service center.
4. Do not drop objects on the product or apply impact.
5. If a gas leakage is found, do not touch the product or power connection. Also, ventilate the area immediately.
6. Do not use or keep combustible spray or an inflammable substance near the product.
7. Do not insert metallic objects (chopsticks, coins, hairpins, etc) or objects that burn easily (paper, matches, etc) into the product.
8. Do not place objects containing liquid (vases, pots, bottles, etc) or metallic objects on top of the product.
9. Leaving the screen fixed on a stationary image for an extended period of time may cause afterimage burn-in or defective pixels.
10. Do not hold the product upside-down.
11. Do not use humidifiers or stoves around the product.
12. Store small accessories out of the reach of children.
13. Do not place heavy objects (e.g. decor frames) on the product.
14. Be careful that children do not place the battery in their mouths when removed from the remote control. Place the battery in a location that children or infants cannot reach.
15. If children have had the battery in their mouths, consult your doctor immediately.
16. When replacing the battery, insert it with the right polarity (+/-).
17. Use only the specified standardized batteries, and do not use a new battery and a used battery at the same time.
18. The batteries are not ordinary refuse and must be returned for recycling purposes. You are responsible for returning the used batteries for recycling. You can return used batteries to a nearby public recycling centre or to a store selling the same type of the battery.

SAFETY PRECAUTIONS

19. Trouble free operation is ensured up to 80% air humidity. To prevent fire or electric shock, never allow liquids to enter the unit.

20. The ambient temperature for operating the device is between +5 and +40 degrees Celsius. Do not install the device in the proximity of heat sources, such as heating pipes, heaters, furnaces or other devices, which radiate heat. It is not absolutely necessary to provide air circulation to dissipate the heat.

21. All maintenance and/or service tasks, as well as repairs may only be carried out by trained customer service personnel.

22. Never let children use electrical devices unsupervised. Children can't always recognize properly the possible dangers.

23. This appliance is intended solely for private domestic use and may not be used for industrial and commercial purposes. We exclude liability in principle if the device is not used as intended, or unauthorized modifications have been made.

24. Packaging and packaging aids are recyclable and should principally be recycled. Packaging materials such as foil bag and cover foil must be kept away from children.



Storage

The product must be stored in dry and well-ventilated rooms, without extreme temperature fluctuations. Heat sources and aggressive active substances may not be stored in the proximity of the device. The required storage temperature is 0° C – +60° C at an air humidity of 5 – 85% RH. The device must be stored in the complete packaging, as delivered.



Home network and Wi-Fi requirements for bathroom application

Overview:

Bathrooms are usually enclosed by walls which cause attenuation. Rooms, on the other hand, have windows which allow cellular/Wi-Fi signal to enter and propagate more easily.

Bathrooms might have metal sheet on the door to prevent its wood from getting soaked. This reflects away most of the RF signal.

There is a network of pipes which impedes signal and creates multipath

Water (and moisture) absorbs radio signal at higher frequencies. This is why microwave ovens operate at ~2.4GHz, which incidentally is the same as WiFi

Minimum Requirements:

You will need a high-speed DSL/Cable modem, or fiber-to-the-home broadband connection for proper playback of Internet-based music and video services.

If your Internet service provider only offers Satellite Internet access, you may experience playback issues due to fluctuating download rates.

In order to take advantage of Smart Mirror's automatic online updates, or stream music and video from an Internet-based content provider, you must install a wireless router in your home network.

If you do not have a wireless router, purchase and install one before proceeding.

Please make sure your router, modem and/or wireless network specifications meet the followings:

Wireless Network Specifications: Open, WEP, WPA-PSK or WPA2-PSK encryption. Wireless Router/Modem Specifications: B,G or N routers on 2.4GHz

Connect a Wi-Fi Range Extender to your Wi-Fi system if:

- You have a larger home where the WiFi performance isn't reliable and you want to strengthen the wireless reception in your bathroom for your Smart Mirror.
- Your WiFi network is already in high demand with streaming video and web surfing and you want to create a separate wireless network exclusively for your Smart Mirror.

Helpful hints once experiencing "buffering" on streaming content.

- Try to move your Wireless Access Point away from physical objects that can block your Wi-Fi signal - especially enclosed cabinets.
- Restart your network device (router, wap, extender etc.)
- Analyze which channel your Wi-Fi is using. You can do this with help Wi-Fi Analyzer app available in play store. Change your router setting in such a way that your channel is different from your neighbors Wi-Fi. The app itself shows recommendations for the channel.



Cleaning and Product Care

1. Use a soft damp cloth (cotton, flannel, etc.) and gently wipe the surface of the product. Wiping with a hard cloth or using strong force may scratch the surface of the product. Never touch, push, rub or strike the screen with any object.
2. Avoid using benzene, thinner and other solvents as they may deform the product and may cause the paint to peel off or damage the surface. Using a chemical cloth (wet/dry sheet type cloth, etc.) may cause damages and corrode the product. To avoid deformation, corrosion and color fading, wipe off water drops as soon as possible.
3. The following items may never be used for cleaning: solvents, cleaning petrol, scrubbing milk, spray cleaner, wax, acids, caustic solutions or the like. These agents may cause damages and corrode the product.

DELIVERY SCOPE

Hardware | What's included

Components may differ in different locations.

Contact the vendor where you purchased the product if any components are missing.

The appearance of the components may differ from the images shown.

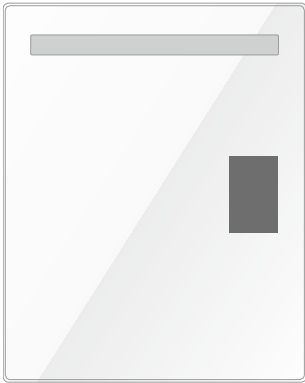

Smart Mirror
Miralite Connect



Bluetooth Remote Control

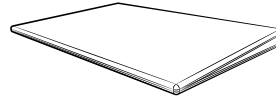

User Manual



Warranty Card

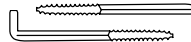

Mounting hooks

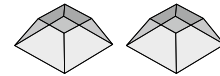

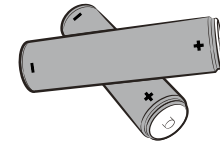

Self-adhesive buffers to
prevent vibrations





Batteries

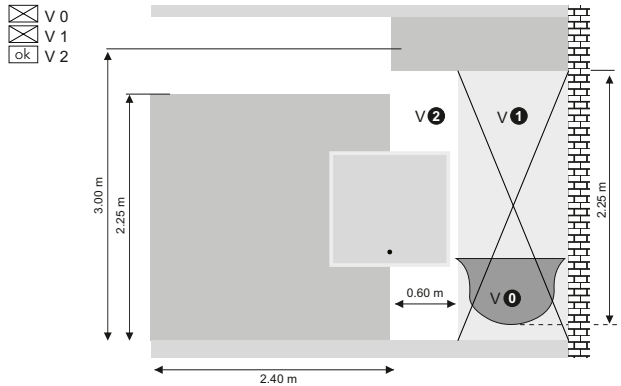

Bathroom Protection Areas

For installations in wet-rooms, such as bathrooms, specific installation guidelines apply. These regulations differ by region. Please contact a specialist for this. Therefore electrical installations are to be performed by a skilled technician, while observing the regulations of the standard DIN VDE 0100 T.701.

  Installation of the product in area V0 and V1 are prohibited. Please refer to the drawing below.



 This product is subject to protection class IP44. This protects the product against splashing water from any angle.

  Please protect the product against water jets and penetrating water.

STEP 1: Attach the appropriate hooks to the wall where the product is to be positioned.

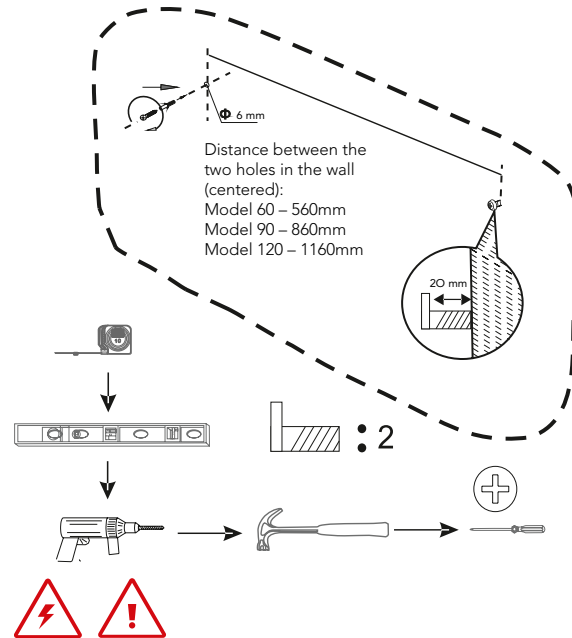

1. There are numerous types of wall and structures, that's why we can not provide the fittings, screws and anchors for your wall. First determine the type of wall to which you want to attach the product in order to buy the appropriate fittings, screws and anchors.

2. Please keep a minimum distance of 15 cm to the next wall on all sides of the product.

INSTALLATION

STEP 2: Stick self-adhesive buffers to the defined spot on the back. Connect the cables of the device to your power supply. Pay attention to the polarity. We recommend this electrical installation to be carried out by trained technical personnel.

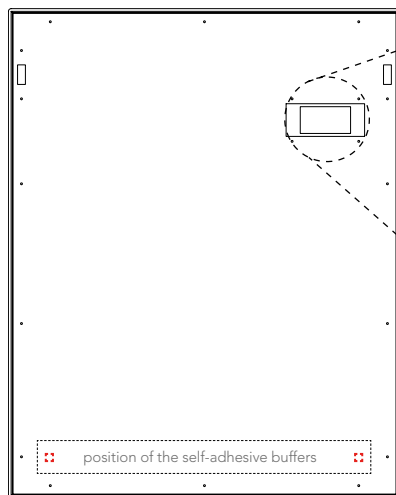

Always switch off the power before starting the installation or maintenance.

The connection of this device to the power supply must be made by using a class 2, IP44 terminal box according to the standard NFC 15-100 and UTE C 15-801 and with a nominal diameter of the connections of 2.5 mm. As soon as the connecting cables used are connected, the terminal box must be closed again so that the cable connection is no longer visible or accessible.

● phase/live

● neutre/neutral

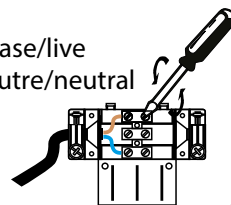

1. No power cord is included.

2. The individual components can be destroyed, if the polarity is reversed or an incorrect connection is used. A goodwill replacement is not possible in such cases, since each device is submitted to meticulous quality inspections prior to shipping. The connecting plugs must be attached in such a way that the connector is held firmly. Have trained technical personnel install the electrical facilities necessary for mounting.

1. It is highly recommended to connect your device to a nonswitched mains power supply (always on).
2. You will be able to switch On/Off the LED lighting using the sensor on the button right of the device.
3. You will be able to switch On/Off the display using the remote control.
4. Connecting your device to a switched mains power supply and/or frequently turning it on and off might reduce your product's lifespan.
5. On first installation please leave your device connected to mains power supply for at least 4 hours.

STEP 3: Hang the product with the hooks and dowels suitable for your wall surface at the recesses.

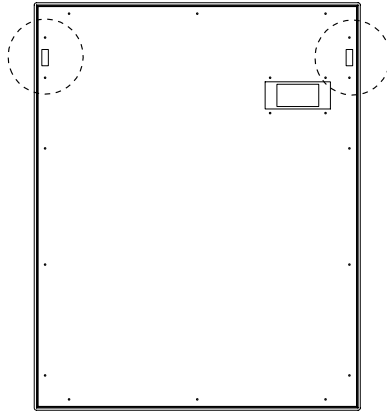

1. Stow the terminal box in the recess provided on the rear of the unit and return the connecting cable to the wall opening, so that the unit is hanging even on the wall and no cables are pinched.
2. To prevent injury, this device must be securely attached to the wall in accordance with the installation instructions. Please ensure that the hooks are locked in the recesses provided on the back of the unit.
3. Do not install the product alone on yourself. Two persons are required to perform a safe installation.
4. The corners and edges of the glass are very delicate. Take care that they do not hit the wall, ceiling or floor in any way to avoid damages and split-offs.
5. If you install the product on a slanted wall, it may fall and result in severe personal injury.
6. Do not install your product while your product is turned on. It may result in personal injury due to electric shock.

STEP 4: Gently pull the film from the mirror surface.



1. The surface of the glass is very sensitive. Do not use a cutter or knife to remove the protective foil in order to avoid scratches and other damages.
2. The product is delivered with a protective film covering the glass in order to avoid scratches and damages. Only remove the protective film once the product is installed and hanging safely on the wall.

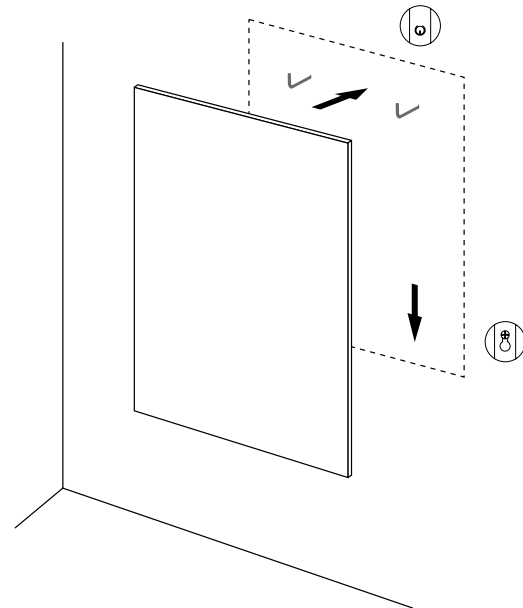

BLUETOOTH REMOTE CONTROL







Bluetooth Remote Control

Insert the batteries into the remote control. Two AAA batteries are required (included in delivery scope). Pay attention to the correct polarity.

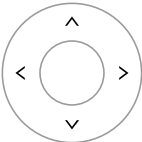

1. The display is always operated with the Bluetooth remote control.
2. The Bluetooth remote control will automatically connect to the unit after approximately three to five seconds.
3. The remote control is not waterproof. To avoid damage, take care that there is no direct contact with water.
4. Make sure your remote is equipped with batteries and that its LED indicator on the top right is lighting once a button is pressed. If the LED indicator is not lighting you need to replace the batteries.



Button	Description
	POWER Power on/off the device – power off will put the device in standby mode.
	DIRECTIONAL NAVIGATION <ul style="list-style-type: none">• Press right to move to the right of your display. Moving to the right from the Home Screen allows you to access more contents.• Press left to move to the left of your display. Moving to the left allows you to return to the Home Screen from any content page.• Press up to move up and press down to move down.
	SELECT Select an item, function or category
	MENU Presents various functions and settings.
	BACK Returns you to the previous screen.
	HOME Returns you to the Home screen from any screen on your device.
	VOLUME Adjust the volume.
	USER KEYS Gets individually configured user profiles.

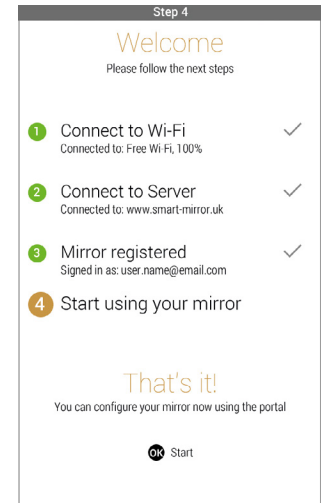
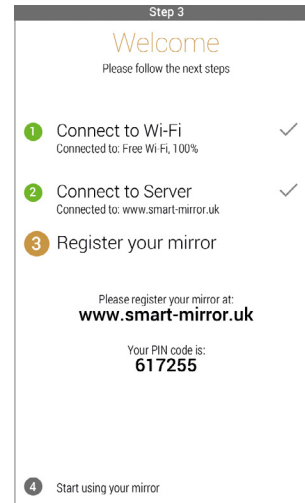
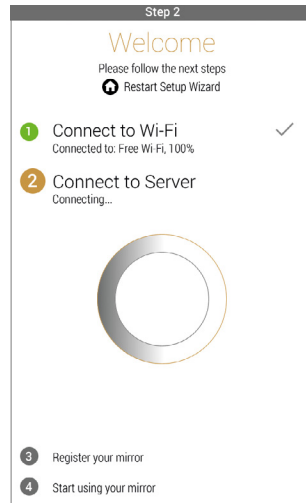
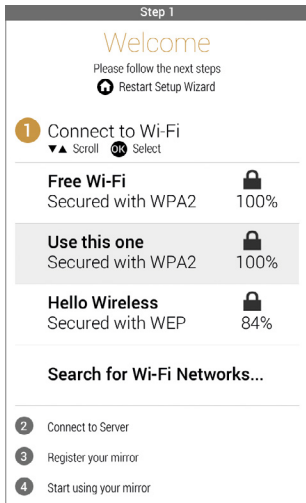

Setup

STEP 1 Connect the device to your WLAN.

If you are connecting to a protected network, you are asked to fill in the password. Please ensure that you are typing in the correct password without any typos.

! The WLAN strength should be over 80% (500 Mbs/s). If this is not the case, we recommend the use of commercially available signal amplifiers.

STEP 2 Wait for your device to connect to the server. This can take a few minutes.

! If the device is not connecting, check that your Internet connection is working properly or that your password has been entered correctly and without any typos. Use the BACK key to return to the password input section.

Registration

STEP 3 The display shows a 6-digit pin code.

Use your computer, tablet or smartphone to register your product in our portal at the displayed domain. Choose „Create Account“ and follow the necessary steps. You will need a valid e-mail address.

For some applications to work correctly, you need to enter the address where you install the product under the location information.

STEP 4 The registration is now complete.

HANDLING

User Portal

www.smart-mirror.net

There you can:

- Add additional devices under „My mirror“
- Change user data under „User“
- The respective user profiles with their settings are displayed on the device as soon as you have pressed the relevant color button (red, green, yellow or blue) on your remote control. Up to 4 user profiles can be created.
- Set up applications to be displayed on your device under „My Applications“

 Use this icon to show or hide the application in your device.

 This icon gives you various options to customize the application.

 With this icon, you can change the arrangement of the applications in the display by means of „Drag & Drop“.



The list of applications can be changed or adjusted by us at any time without prior notice. It is therefore useful to visit the portal from time to time to use new applications.

When you make changes in the portal, it takes about 30 seconds to activate them and appear on your device.

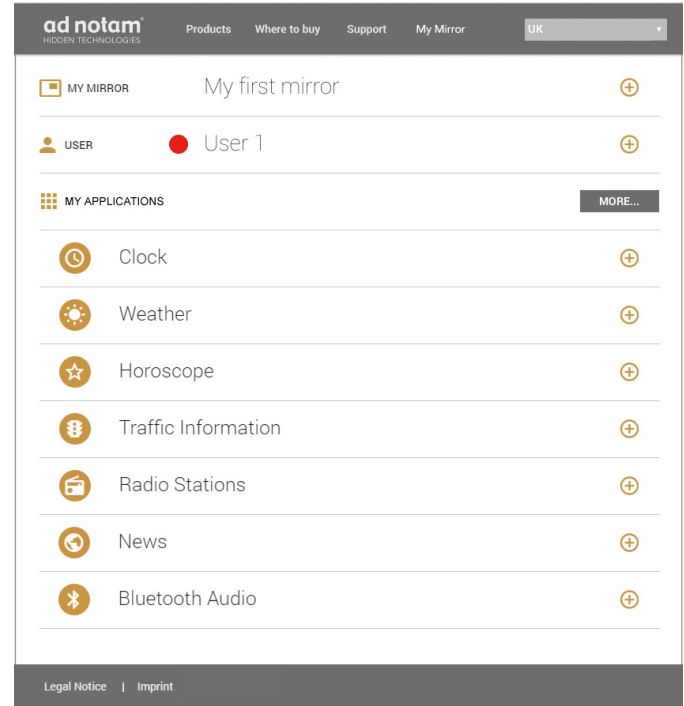

Mirror Defogger

The unit has a built-in mirror heater which ensures that the mirror is not fogged. The mirror heater is automatically activated as soon as the unit is switched on, defogger can be switched off.

Loudspeaker

The device has an integrated surface loudspeaker.



Ensure that the device is stuck on the wall to prevent vibrations, as they can adversely affect sound quality.

Lighting

The integrated light is controlled by a sensor at the lower right edge of the device. When you touch the sensor, you can control the illuminance in 5 steps – each touch changes the intensity. When you long press on the sensor, you can adjust the lighting color.

Bluetooth Audio

You can play music content from your smartphone or tablet on the device via Bluetooth. To do this, activate the Bluetooth in your smartphone or tablet and connect it to the device – the device is displayed as „AD NOTAM BT“. PIN input is not required. As soon as you play music on your smartphone or tablet, it will be played back on the device if it supports your application.



Do not remove the device from the Bluetooth device list on your smartphone or tablet – it can happen that it can not be detected anymore.

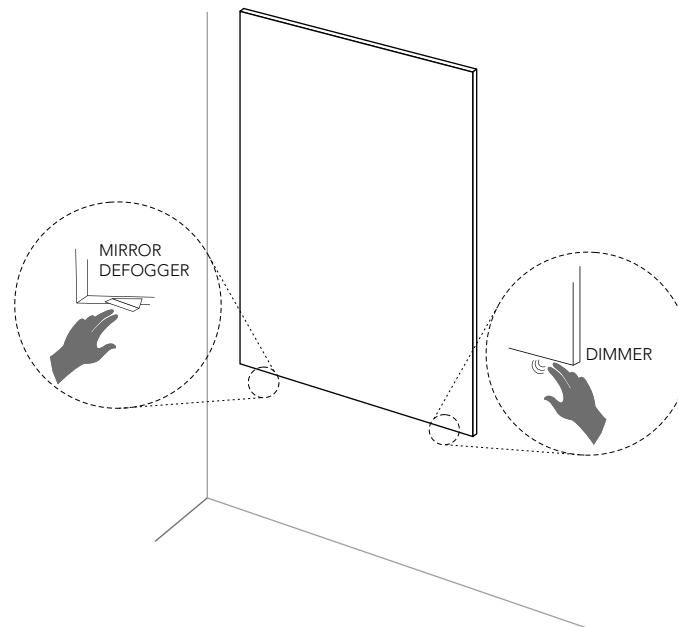

DISPLAY HANDLING

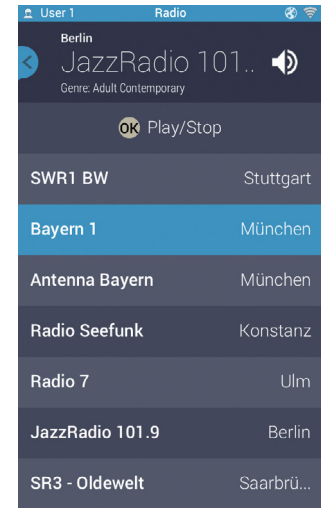
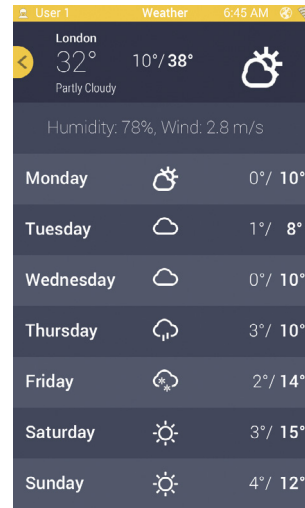
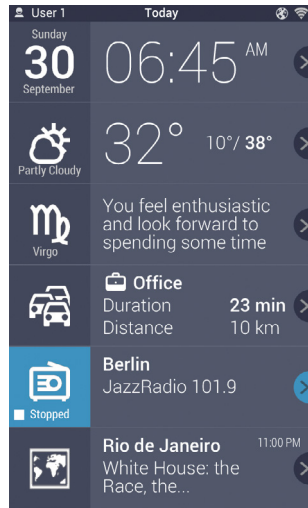
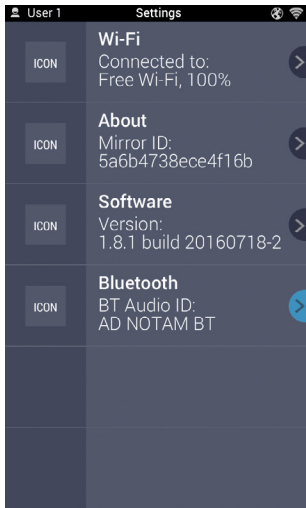

How to operate the device with your remote control

Use the NAVIGATION buttons on your remote control to scroll and confirm with OK. Use the HOME button on the remote control to return to the „main screen“. Here you can see all applications at a glance. Use the NAVIGATION buttons to navigate through the applications.

Use the right NAVIGATION button to get more information on applications (e.g. the weather) or select various options, for example, which radios you want to listen to. You must of course set these up in the portal beforehand (see p.13).

Use the left NAVIGATION button, the BACK button or the HOME button to return to the main screen.

The MENU button is used to access the settings of the device. There you can:

- Select and setup WLAN network
- Get more information about your device
- Make settings: Reload, reboot, reset to factory default.

⚠ You can reset the device to the factory settings, e.g. when the device owner changes. In this case, you must perform the portal registration again.

GENERAL INFORMATION	MIRALITE CONNECT 60 556.642	MIRALITE CONNECT 90 556.654	MIRALITE CONNECT 120 556.666
Installation method	On-Wall Installation	On-Wall Installation	On-Wall Installation
Product Dimensions	600 W x 750 H x 45 D mm	900 W x 750 H x 45 D mm	1200 W x 750 H x 45 D mm
Product Weight	Net: 9.4 kg / Gross: 10.0 kg	Net: 12.8 kg / Gross: 13.6 kg	Net: 16.3 kg / Gross: 17.4 kg
Product Usage	For In-Door Use only	For In-Door Use only	For In-Door Use only
Operating Temperature	5° to 40° Celcius	5° to 40° Celcius	5° to 40° Celcius
Humidity	20% – 80%	20% – 80%	20% – 80%
Storage Temperature	0° to 60° Celcius	0° to 60° Celcius	0° to 60° Celcius
MIRROR			
Type Surface Tint	Crystal Mirror 4 mm Float – non-safety Neutral	Crystal Mirror 4 mm Float – non-safety Neutral	Crystal Mirror 4 mm Float – non-safety Neutral
SURFACE LOUDSPEAKER			
Type Rated Power Impedance	Single 30W, max. power 60W 8 Ohm	Single 30W, max. power 60W 8 Ohm	Single 30W, max. power 60W 8 Ohm
LIGHTING			
Type Luminance ^{1,2}	LED 144 Lux @ 80cm (diffused)	LED 144 Lux @ 80cm (diffused)	LED 144 Lux @ 80cm (diffused)
Color ^{1,2}	2700 K – 6000 K, changeable (progressive)	2700 K – 6000 K, changeable (progressive)	2700 K – 6000 K, changeable (progressive)
Dimmer	yes, 4 levels	yes, 4 levels	yes, 4 levels
Power Consumption ¹	9.21W	13.40W	19.20W
Sensors	1x IR Sensor at bottom of mirror	1x IR Sensor at bottom of mirror	1x IR Sensor at bottom of mirror
BLUETOOTH AUDIO			
Device Address	AD NOTAM BT	AD NOTAM BT	AD NOTAM BT
Range Power	Typical: 10m Max.: 15.5W	Typical: 10m Max.: 15.5W	Typical: 10m Max.: 15.5W
ACCESSORIES			
Switchable defogger	50 x 20 cm, 21W	50 x 30 cm, 29W	50 x 30 cm, 29W
DISPLAY			
Backlight/ Lifetime	LED / 15.000 Hours	LED / 15.000 Hours	LED / 15.000 Hours
Screen Diagonale	178mm (7")	178mm (7")	178mm (7")
Picture Format Physical Resolution	9:16 600 x 1024	9:16 600 x 1024	9:16 600 x 1024
Wifi Bluetooth	802,11b/g/n 2.4 GHz single-band radio 4.0	802,11b/g/n 2.4 GHz single-band radio 4.0	802,11b/g/n 2.4 GHz single-band radio 4.0



Low Standby Power
Our highly advanced power circuitry brings down power consumption to an extremely low level while in standby mode.

¹ Value might vary slightly ² Areas may appear with a slightly deviating shade

- Product specifications are subject to change without notice.
- For more specification details of this product, visit our website at: www.smart-mirror.net

GENERAL INFORMATION

Certificates



Patent Information

This product, parts, components and the assembly are protected by or might be part of one or more of the following intellectual property rights:

US 7455412 B2 / US 7589893 B2 / EP 1168285 B2 / EP 1429308 B2 / EP 1809828 B1

Warranty

Only the warranty provisions set out in the enclosed warranty certificate apply. Please pay particular attention to the information on the waiver of warranty.

Terms of Use and Guidelines

Before using the product, please read the conditions on www.smart-mirror.net. Please also read all the rules, notices, and policies related to the product and related services, including, but not limited to, the privacy policy, as well as any other policies or terms of use accessible through the website www.smart-mirror.net. All conditions, rules, references, guidelines and disposals are collectively referred to as the „Agreement“.

When using this product, you agree to the terms of the agreement.

Contact information. Please address all communication regarding the agreement to in writing:

ad notam AG – Obere Giesswiesen 11-13, 78247 Hilzingen, Germany

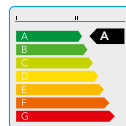

EUROPEAN ENERGY LABEL

The European Energy Label informs you on the energy efficiency class of this product. The greener the energy efficiency class of this product is, the lower the energy it consumes. On the label you can find the energy efficiency class.



DISPOSAL OF OLD EQUIPMENT AND BATTERIES

(European Union)

The following symbols indicate that electrical resp. electronic equipment and batteries signed with this symbol should not be disposed of as general household waste at its end of life. Instead, the products should be handed over to the applicable collection points for the recycling of electrical and electronic equipment as well as batteries for proper treatment, recovery and recycling in accordance with your national legislation and the Directive 2002/96/EC and 2006/66/EC.

By disposing of the products correctly, you will help to conserve natural resources and will help to prevent potential negative effects on the environment and human health which could otherwise be caused by inappropriate waste handling of these products. For more information about collection points and recycling of these products, please contact your local municipal office or your household waste disposal service. Penalties may be applicable for incorrect disposal of this waste, in accordance with national legislation.

(Other Countries outside the European Union) These symbols are only valid within the European Union. If you wish to dispose of these items, please do so in accordance with the applicable national legislation or other rules of your country for the treatment of old electrical and electronic equipment and batteries.

For further questions or troubleshooting, please visit the support section on our website www.smart-mirror.net and read the available FAQs.

In the online support, you can select your language and enter the model name of your product.

If this does not help you, please send us an email or contact the service center indicated on the website.



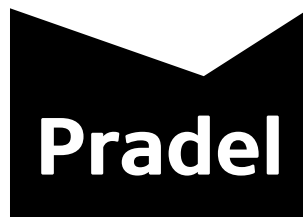

Pierre Pradel Paris
Parc Eurostore

95/97 rue du Moulin de Cage – Bat B1
92230 Gennevilliers

Tel : +33 1 41 37 79 79 puis tapez 1

PradelADV.CFRGEN@saint-gobain.com
<http://www.pradel-decoration.com>